

SPECIFICATION SHEET **FEBCO**

MASTER series

MasterSeries® 870V

Double Check Valve Assemblies

Size: 2½" - 10" (65mm - 250mm)

The FEBCO MasterSeries® 870V Double Check Valve Assemblies are designed for non-health hazard applications. Standard orientation is inlet flow vertical up, outlet flow vertical down. Vertical orientation is inlet and outlet flow vertical up.

Materials

Main Valve Body:	Ductile iron Grade 65-45-12
Coating:	Fusion epoxy coated internal and external AWWA C550-90
Shutoff Valves:	NRS and OS&Y resilient wedge gate valves AWWA C509
Trim:	Bronze
Elastomer Discs:	EPDM
Spring:	Stainless steel

Pressure – Temperature

Max. Working Pressure:	175psi (12.1 bar)
Hydrostatic Test Press:	350psi (24.1 bar)
Temperature Range:	32°F to 140°F (0°C to 60°C)

Approvals

- ANSI/AWWA (C510-89)

Approved by the Foundation for Cross-Connection Control and Hydraulic Research at the University of Southern California.



* Less gate not FM approved. Less gate not UL Classified unless installed with UL Listed gate valves.

Models

- Valve Setter with MJ x MJ, MJ x FL, or FL x FL ends
- UL/FM OS&Y RW Gate Valves
- Wye Strainer
- End Connections: Flanged ANSI B16.1
Class 125

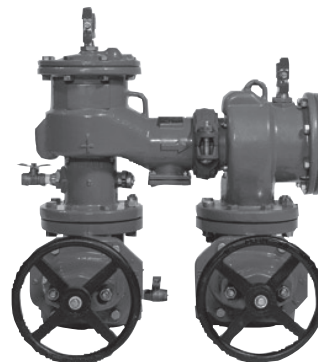

MODEL 870V DOUBLE CHECK ASSEMBLY
(Shown in standard orientation)

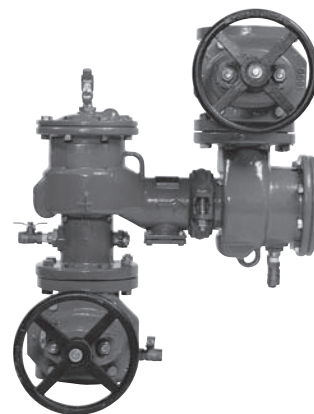

MODEL 870V DOUBLE CHECK ASSEMBLY
(Shown in vertical orientation)

U.S. Patent No. 4,989,635 • U.S. Patent No. 5,107,888
U.S. Patent No. 5,385,166 • U.S. Patent No. 5,226,441
U.S. Patent No. 5,392,803 • U.S. Patent No. 5,503,176

Job Name _____

Job Location _____

Engineer _____

Approval _____

Contractor _____

Approval _____

Contractor's P.O. No. _____

Representative _____

FEBCO product specifications in U.S. customary units and metric are approximate and are provided for reference only. For precise measurements, please contact FEBCO. FEBCO reserves the right to change or modify product design, construction, specifications, or materials without prior notice and without incurring any obligation to make such changes and modifications on FEBCO products previously or subsequently sold.

Series 870V / Materials of Construction

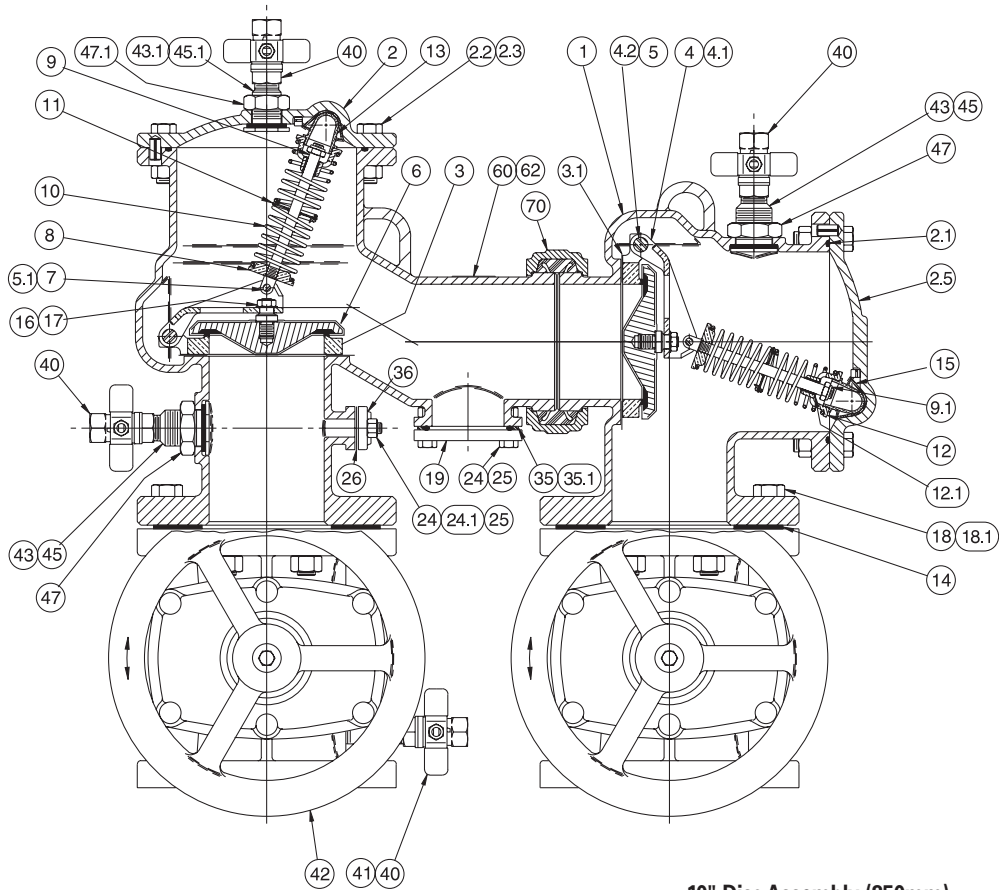

10" Disc Assembly (250mm)

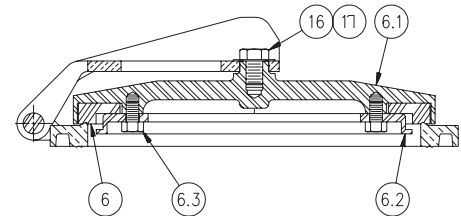

#	DESCRIPTION	MATERIAL	#	DESCRIPTION	MATERIAL
1	Body	A536 GR 65-45-12	13	Pivot Bearing	B585 Alloy C83600
2	Cover	A536 GR 65-45-12	14	Flange Gasket	Rubber/Fabric
2.1	O-ring	EPDM ASTM D2000	15	Bearing Socket	Acetal Resin
2.2	Cap Screw	Plated Steel	16	Hex Jam Nut	18-8 SS
2.3	Hex Nut	Plated Steel	17	Capscrew (10" Only)	18-8 SS
2.5	Cover (w/o holes)	A536 GR 65-45-12	19	Washer	302 SS
3	Seat Ring	B524 Alloy C83600	18	Flange Nut	Plated Steel
3.1	Gasket	EPDM ASTM D2000	18.1	Flange Nut	Plated Steel
4	Arm	B584 Alloy C83600	19	Cover	A36 Stl. Epoxy Coated
4.1	Bushing-Swing Pin	Acetal Resin	24	Bolt	Plated Steel
4.2	Swing Pin	304 SS	24.1	Washer	Plated Steel
5	Retaining Clip	302 SS	25	Nut	Plated Steel
5.1	Retaining Clip	302 SS	26	Gasket	EPDM ASTM D2000
6	Check Disk (21/2" - 8")	EPDM Coated GR, 45 Ductile Iron w/ type 304 SS	35	O-ring	EPDM ASTM D1999
	Seat Disc (10" Only)	Silicone ASTM D2000	35.1	Back Up Ring	Acetal Resin
6.1	Disc Holder (10" Only)	ASTM A743 304 SS	36	Cover	B584 Alloy C83600
6.2	Disc Retainer (10" Only)	ASTM A743 304 SS	40	Ball Valve	B584 Alloy C83600
6.3	Capscrew (10" Only)	18-8 SS	41	Nipple	Brass
7	Load Pin	304SS	42	Gate Valve (NRS)	AWWA C509
8	Lower Sprng. Retainer	B584 Alloy C83600	43	Bulkhead Fitting	B584 Alloy C83600
9	Spring Stem	304SS	43.1	Bulkhead Fitting	B584 Alloy C83600
9.1	Elastic Stop Jam Nut	18-8 SS	45	Gasket	EPDM ASTM D2000
10	Spring	A313 Type 631 SS	45.1	Gasket	EPDM ASTM D2001
11	Spring Guide	B130 Alloy C22000	47	Nut	B584 Alloy C83601
12	Upper Sprng. Retainer	B584 Alloy C83600	47.1	Nut	B584 Alloy C83602
12.1	Bushing Sprng. Stem	Acetal Resin	60	Identification Plate	B36 Alloy C26000
			62	Drive Screw	Stainless Steel
			70	Clamp 870V Only	AWWA C606

Model 870V
Standard Orientation

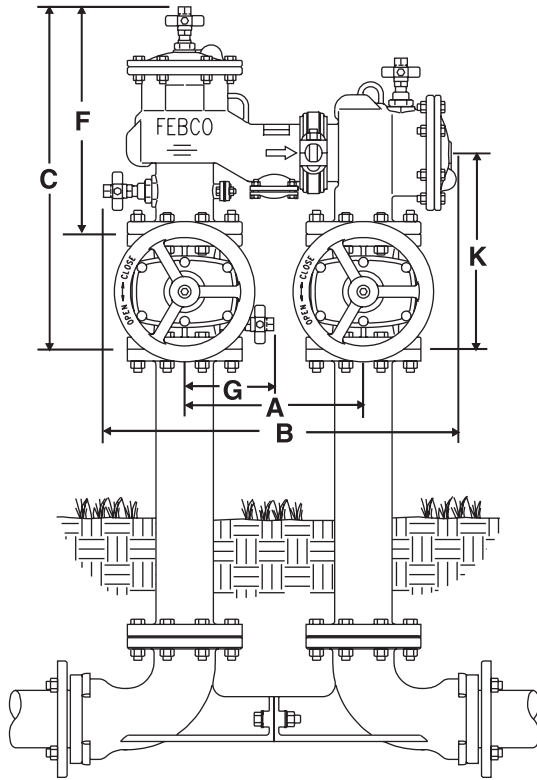

Note: The Model 870V is shipped in the standard (N-Shape) orientation as shown above.

Model 870V
Vertical Orientation

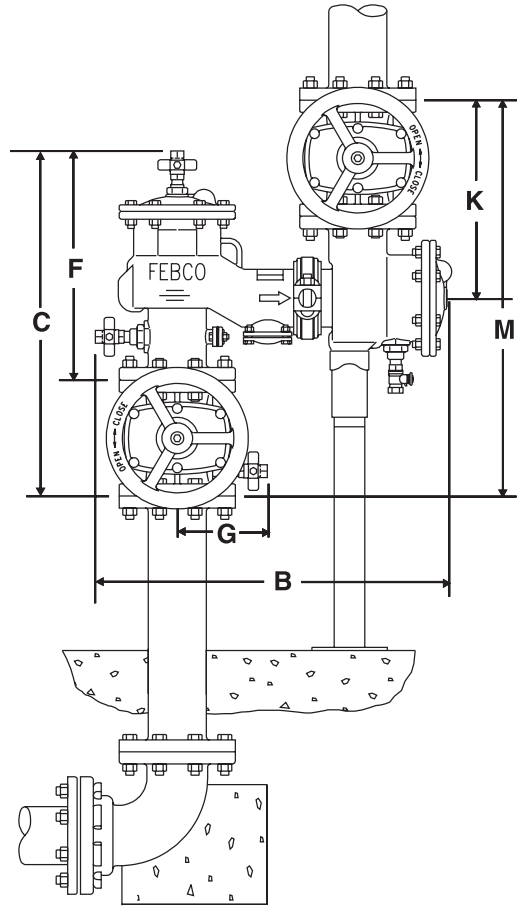

NRS Side View

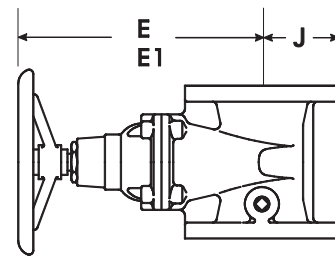

Dimensions – Weights

Size: 2½" - 10" (65 - 250mm)

SIZE (DN)		DIMENSIONS														WEIGHT									
		A		B		C		E NRS		E1 OS&Y*		F		G		J		K		M		NRS		OS&Y	
in.	mm	in.	mm	in.	mm	in.	mm	in.	mm	in.	mm	in.	mm	in.	mm	in.	mm	in.	mm	in.	mm	lbs	kgs.	lbs.	kgs.
2½	65	12½	318	25¾	654	24¼	616	12⅝	321	16⅜	416	16⅝	422	6¼	159	3½	89	13⅝	346	27¼	692	190	86	200	91
3	80	12½	318	25¾	654	24¾	629	12⅞	327	22¼	565	16⅝	422	6¼	159	3¾	95	14⅞	359	28¼	718	260	118	270	123
4	100	14	356	27⅞	708	26¾	680	14⅜	365	23¼	591	17¾	451	7	178	4½	114	15½	394	31	787	300	136	320	145
6	150	16	406	32¼	819	32¼	819	18⅞	497	30⅞	765	21⅞	548	8	203	5½	140	18⅞	473	37¼	946	460	209	500	227
8	200	18½	470	37½	953	36⅞	924	23½	597	37¾	959	24⅞	632	9¼	235	6¾	172	20¾	527	41½	1054	780	354	840	381
10	250	21	533	42½	1080	40¾	1035	27½	699	48	1219	27½	699	10	254	8	203	24	610	48	1219	1320	599	1450	658

*OS&Y OPEN

Weights do not include risers or optional valve setter.
Note: Dimensions shown are nominal. Allowances must be made for normal manufacturing tolerances.
Refer to Specification Sheet ES-F-611 for details on valve setter.

Typical Installation

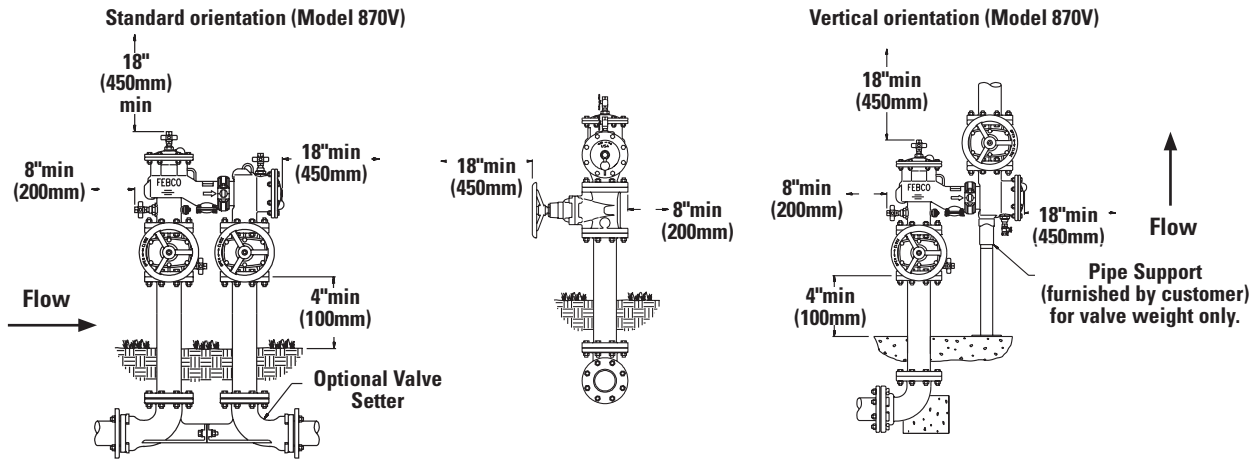

Recommended minimum clearances from permanent structures for ease of testing and maintenance are shown on above drawings.

Capacity

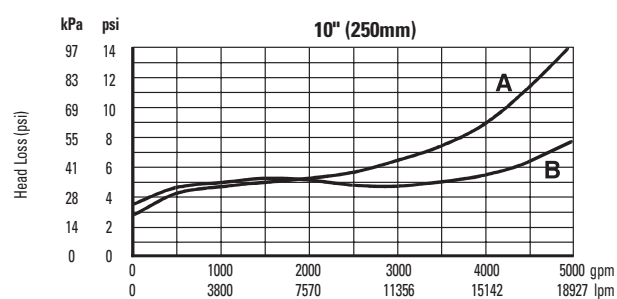
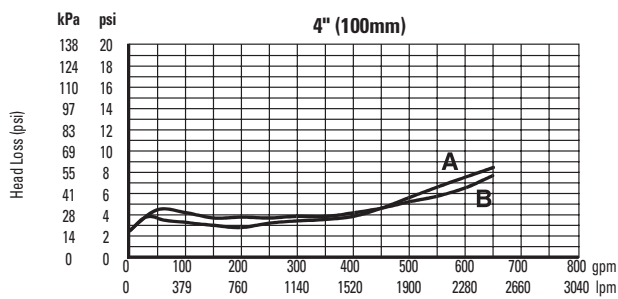
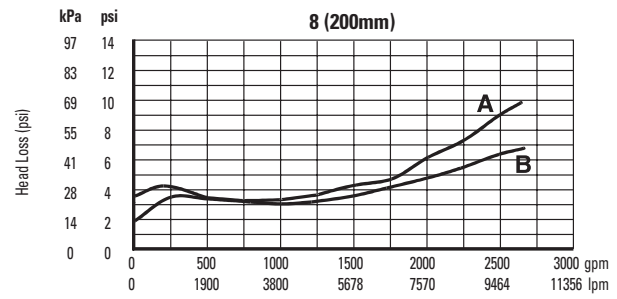
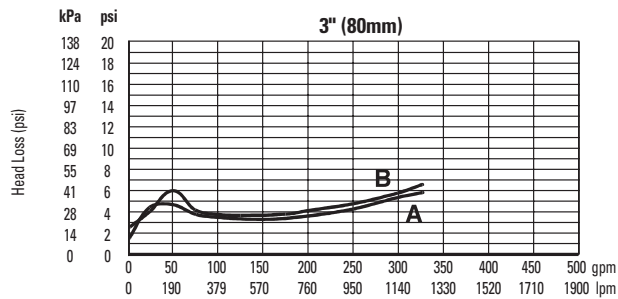
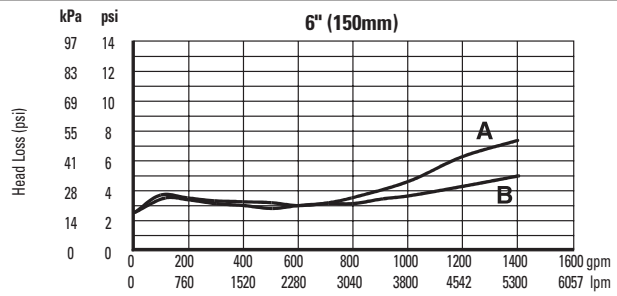
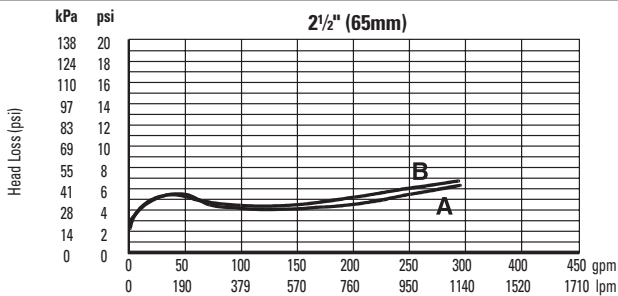

A-Vertical orientation
B-Standard orientation

The 6" and 10" flow curves (B-standard orientation) include the FEBCO valve setter Series 611.

