



TECHNICAL DATA

STANDARD RESPONSE PENDENT SPRINKLER VK592 (K19.6) (CONTROL MODE SPECIFIC APPLICATION)

The Viking Corporation, 210 N Industrial Park Drive, Hastings MI 49058

Telephone: 269-945-9501 Technical Services: 877-384-5464 Fax: 269-818-1680 Email: techsvcs@vikingcorp.com

1. DESCRIPTION

Viking Standard Response Control Mode Specific Application (CMSA) Pendent Sprinkler VK592 is a thermosensitive fusible element type spray sprinkler. With a 19.6 nominal K-Factor, the sprinkler provides greater flows at lower pressures than sprinklers with smaller K-Factors. This feature allows reduced pipe sizing for hydraulically calculated sprinkler systems, and provides the higher densities required to allow an increase in the hazard classification of an occupancy. Viking Standard Response Sprinkler VK592 was subjected to full-scale high piled storage fire testing and is UL Listed, FM Approved, and VdS Approved for use in protecting high-piled storage.

Viking Sprinkler VK592 is intended to protect Class I-IV commodities and plastic and rubber commodities (cartoned, unexpanded only) stored palletized, solid piled, bin boxes, shelf storage, and single, double, multiple row, and portable open rack storage (no open-top containers or solid shelves). Sprinkler VK592 may also be used to protect on-floor storage of idle wood pallets. Refer to Approval Chart 1 and Design Criteria on pages 114n-r for UL Listing requirements, and refer to Approval Chart 2 and Design Criteria on page 114s for FM Approval requirements that must be followed.

NOTE: Sprinkler VK592 is NOT approved for protecting expanded plastics, exposed unexpanded plastics, rolled paper, baled cotton, aerosols, or rubber tires.

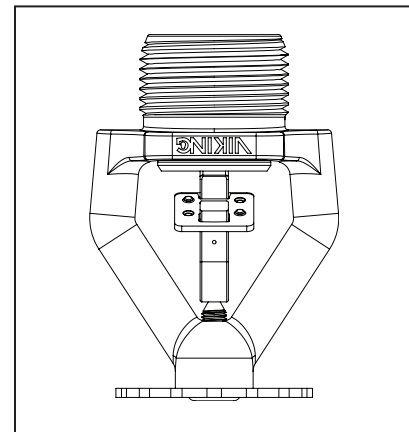

WARNING: Cancer and Reproductive Harm-
www.P65Warnings.ca.gov

2. LISTINGS AND APPROVALS



UL Listed: Category VNIV



FM Approved: Class 2036



VdS Approved: Certificate G4080016

Refer to Approval Chart 1 and Design Criteria on pages 114n-r for UL Listing requirements, for the U.S. and Canada, and refer to Approval Chart 2 and Design Criteria on page 114s for FM Approval requirements that must be followed.

3. TECHNICAL DATA

Specifications:

Available since 2008.

Maximum Working Pressure: 175 psi (12 bar). Factory tested hydrostatically to 500 psi (34.5 bar).

Thread size: Base Part No. 14243: 1" NPT, Part No. 15468: 25 mm BSP

Nominal K-Factor: 19.6 U.S. (282.6 metric*)

* Metric K-factor measurement shown is when pressure is measured in Bar. When pressure is measured in kPa, divide the metric K-factor shown by 10.0.

Overall Length: 3-3/16" (81 mm)

Covered by one or more of the following patents: US5,829,532; US6,059,044; US6,336,509; US6,502,643; US6,868,917

Material Standards:

Sprinkler Frame: Brass UNS-C84400

Deflector: Phosphor Bronze UNS-C51000

Seat and Insert Assembly: Copper UNS-C11000 and Stainless Steel UNS-S30400

Compression Screw: Stainless Steel UNS-S31603

Belleville Spring Sealing Assembly: Nickel Alloy, coated on both sides with Teflon Tape

Trigger and Support: Stainless Steel UNS-S31600

Fusible Element Assembly: Phosphor Bronze UNS-C51000, polyurethane coated

Ordering Information: (Also refer to the current Viking price list.)

Order Standard Response Control Mode Specific Application Pendent Sprinkler VK592 by adding the appropriate suffix for the sprinkler temperature rating to the sprinkler base part number.

Finish Suffix: Brass = A

Temperature Suffix: 160 °F (71 °C) = C, 205 °F (96 °C) = E

For example, sprinkler VK592 with a Brass finish, with 1" NPT threads, and a 160 °F (71 °C) temperature rating = Part No. 14243AC.

Available Finishes And Temperature Ratings: Refer to Table 1.

Viking Technical Data may be found on
The Viking Corporation's Web site at
<http://www.vikinggroupinc.com>.
The Web site may include a more recent
edition of this Technical Data Page.



TECHNICAL DATA

STANDARD RESPONSE PENDENT SPRINKLER VK592 (K19.6) (CONTROL MODE SPECIFIC APPLICATION)

The Viking Corporation, 210 N Industrial Park Drive, Hastings MI 49058

Telephone: 269-945-9501 Technical Services: 877-384-5464 Fax: 269-818-1680 Email: techsvcs@vikingcorp.com

Accessories: (Also refer to the "Sprinkler Accessories" section of the Viking data book.)

Sprinkler Wrench: Part No. 13635W/B (double-ended wrench - Use Side B. Available since 2006.)

Sprinkler Cabinets: Six-head capacity: Part No. 01731A (available since 1971)

4. INSTALLATION

Refer to appropriate NFPA Installation Standards.

5. OPERATION

During fire conditions, the heat-sensitive fusible element assembly disengages, releasing the seat and spring assemblies to open the waterway. Water flowing through the sprinkler orifice strikes the sprinkler deflector, forming a uniform spray pattern to extinguish or control the fire.

6. INSPECTIONS, TESTS AND MAINTENANCE

Refer to NFPA 25 for Inspection, Testing and Maintenance requirements.

7. AVAILABILITY

The Viking Model VK592 Sprinkler is available through a network of domestic and international distributors. See The Viking Corporation web site for the closest distributor or contact The Viking Corporation.

8. GUARANTEE

For details of warranty, refer to Viking's current list price schedule or contact Viking directly.

TABLE 1: AVAILABLE SPRINKLER TEMPERATURE RATINGS AND FINISHES

Sprinkler Temperature Classification	Sprinkler Nominal Temperature Rating ¹	Maximum Ambient Ceiling Temperature ²	Frame Paint Color
Ordinary	160 °F (71 °C)	100 °F (38 °C)	None
Intermediate	205 °F (96 °C)	150 °F (65 °C)	White

Sprinkler Finish: Brass

Footnotes

¹ The sprinkler temperature rating is stamped on the deflector.

² Based on NFPA-13. Other limits may apply, depending on fire loading, sprinkler location, and other requirements of the Authority Having Jurisdiction. Refer to specific installation standards.

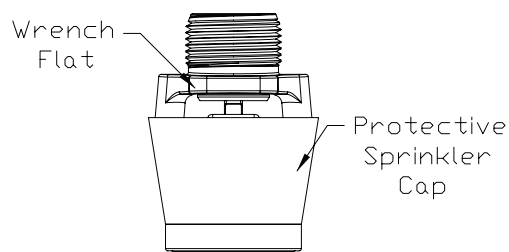

Use Side B for
Pendent K19.6
Sprinkler VK592

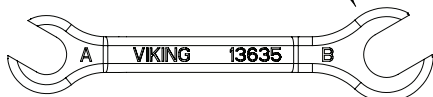

Figure 1: Pendent Sprinkler Wrench 13635W/B

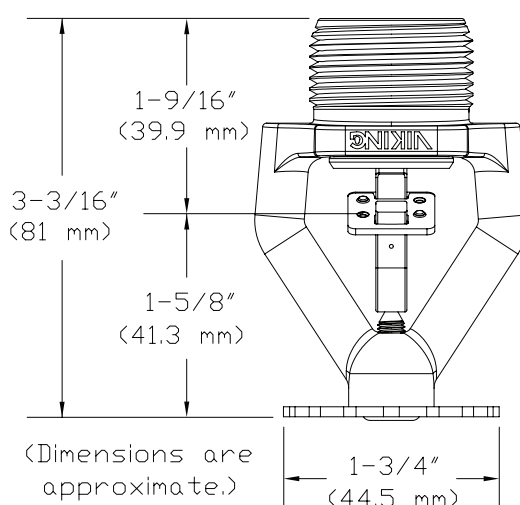

Figure 2: Pendent Sprinkler VK592 Dimensions



TECHNICAL DATA

STANDARD RESPONSE PENDENT SPRINKLER VK592 (K19.6) (CONTROL MODE SPECIFIC APPLICATION)

The Viking Corporation, 210 N Industrial Park Drive, Hastings MI 49058

Telephone: 269-945-9501 Technical Services: 877-384-5464 Fax: 269-818-1680 Email: techsvcs@vikingcorp.com

Approval Chart 1 (UL)

Standard Response Control Mode Specific Application (CMSA) Pendent Sprinkler VK592 (K19.6)
Maximum 175 PSI (12 Bar) WWP

Temperature	KEY
Finish	
Escutcheon (if applicable)	
A1X	

Base Part Number ¹	SIN	Thread Size	Nominal K-Factor		Overall Length		Listings and Approvals ³ (Refer also to Design Criteria below and on pages 114o-r.)		
			U.S.	metric ²	Inches	mm	UL	NYC	VdS
14243A	VK592	1" NPT	19.6	282.6	3-3/16	81	A1	See Footnote 4.	B1
15468A	VK592	25 mm BSP	19.6	282.6	3-3/16	81	A1	See Footnote 4.	B1
Approved Temperature Ratings A - 160 °F (71 °C) and 205 °F (96 °C) B - 160 °F (71 °C)						Approved Finish 1 - Brass			

Footnotes

¹ Base part number shown. For complete part number, refer to Viking's current price schedule.

² Metric K-factor measurement shown is when pressure is measured in Bar. When pressure is measured in kPa, divide the metric K-factor shown by 10.0.

³ This table shows the listings and approvals available at the time of printing. Other approvals may be in process.

⁴ Meets New York City requirements, effective July 1, 2008.

DESIGN CRITERIA - UL

(Also refer to Approval Chart 1 above.)

UL Listing Requirements: (NOTE: The FM Approval requirements differ from UL and/or NFPA criteria. Refer to pages 114s-t for FM requirements.)

Design Criteria: Sprinkler VK592 is UL Listed for use in the U.S. and Canada for High Piled Storage Occupancies with the minimum operating pressures as indicated in Tables 3-9 on pages 114p-q.

Hydraulic Calculations: Hydraulic calculations must be done in accordance with NFPA 13 for Control Mode Specific Application (CMSA) sprinklers.

System Type: Wet systems only.

Maximum Roof or Ceiling Slope: 2 in 12 (167 mm/m or 9.5 degrees).

Sprinkler Position: Approved for use only in the pendent position. Align the deflector parallel with the ceiling or roof.

Clearance from Deflector to Top of Storage: At least 36" (914 mm).

Determination of the Protection Area of Coverage: The protection area of coverage per sprinkler (A_s) is determined as follows: $A_s = S \times L$

To determine S, measure the distance between sprinklers (or to wall or obstruction in the case of the end sprinkler on the branch line) upstream and downstream along the branch line. Choose the larger of either twice the distance to the wall (or obstruction) or the distance to the next sprinkler. This dimension is S.

To determine L, measure the perpendicular distance to the sprinkler on the adjacent branch line (or to a wall or obstruction in the case of the last branch line) on each side of the branch line on which the subject sprinkler is positioned. Choose the larger of either twice the distance to the wall (or obstruction) or the distance to the next sprinkler. This dimension is L.

Maximum Protection Area of Coverage: The maximum allowable protection area of coverage for a sprinkler (A_s) shall be 100 ft² (9.3 m²), as indicated in Table 2. Deviations from the maximum sprinkler spacing are allowed to eliminate obstructions created by structural elements (such as trusses, bar joists, and wind bracing) by moving either a sprinkler or a branch line as follows:

- Moving a sprinkler along the branch line a maximum of 1 ft (0.3 m) from its allowable spacing, provided coverage for that sprinkler does not exceed 110 ft² (10.2 m²) per sprinkler where all of the following conditions are met:
 - The average actual floor area protected by the moved sprinkler and the adjacent sprinklers does not exceed 100 ft² (9.3 m²).
 - Adjacent branch lines maintain the same pattern.
 - The distance between sprinklers doesn't exceed 12 ft (3.7 m).
- Moving a single branch line a maximum of 1 ft (0.3 m) from its allowable spacing, provided coverage for the sprinklers on that branch line and the sprinklers on the branch line it is moving away from does not exceed 110 ft² (10.2 m²) per sprinkler where all of the following conditions are met:
 - The average actual floor area protected by the sprinklers on the moved branch line and the sprinklers on the adjacent branch lines does not exceed 100 ft² (9.3 m²) per sprinkler.
 - The distance between sprinklers doesn't exceed 12 ft (3.7 m).
 - It is NOT permitted to move a branch line where there are moved sprinklers on a branch line that exceed the maximum sprinkler spacing.

Minimum Protection Area of Coverage: The minimum allowable protection area of coverage per sprinkler (A_s) is 64 ft² (5.9 m²).

Maximum Distance Between Sprinklers: The maximum distance between sprinklers shall be limited to not more than 12 ft (3.7 m), as shown in Table 2.

- Deviations from the maximum sprinkler spacing are allowed to eliminate obstructions created by trusses and bar joists by moving a sprinkler along the branch line a maximum of 1 ft (0.3 m) from its allowable spacing, provided coverage for that sprinkler does not exceed 110 ft² (10.2 m²) where ALL of the following conditions are met:
 - The average actual floor area protected by the sprinklers on the moved branch line and the sprinklers on the adjacent branch lines doesn't exceed 100 ft² (9.3 m²) per sprinkler.



TECHNICAL DATA

STANDARD RESPONSE PENDENT SPRINKLER VK592 (K19.6) (CONTROL MODE SPECIFIC APPLICATION)

The Viking Corporation, 210 N Industrial Park Drive, Hastings MI 49058

Telephone: 269-945-9501 Technical Services: 877-384-5464 Fax: 269-818-1680 Email: techsvcs@vikingcorp.com

UL Listing Requirements (continued):

- The distance between sprinklers doesn't exceed 12 ft (3.7 m).
- It is NOT permitted to move a branch line where there are moved sprinklers on a branch line that exceed the maximum sprinkler spacing.

Minimum Protection Area of Coverage: The minimum allowable protection area of coverage per sprinkler (A_s) is 64 ft² (5.9 m²).

Maximum Distance Between Sprinklers: The maximum distance between sprinklers shall be limited to not more than 12 ft (3.7 m), as shown in Table 2.

1. Deviations from the maximum sprinkler spacing are allowed to eliminate obstructions created by trusses and bar joists by moving a sprinkler along the branch line a maximum of 1 ft (0.3 m) from its allowable spacing, provided coverage for that sprinkler does not exceed 110 ft² (10.2 m²) where ALL of the following conditions are met:

- The average actual floor area protected by the sprinklers on the moved branch line and the sprinklers on the adjacent branch lines doesn't exceed 100 ft² (9.3 m²) per sprinkler.
- The distance between sprinklers doesn't exceed 12 ft (3.7 m).
- It is permitted to move a branch line where there are moved sprinklers on a branch line that exceed the maximum sprinkler spacing.

2. Where branch lines are parallel to trusses and bar joists, deviations from the maximum sprinkler spacing are allowed to eliminate obstructions created by trusses and bar joists by moving a single branch line a maximum of 1 ft (0.3 m) from its allowable spacing, provided coverage for the sprinklers on that branch line and the sprinklers on the branch line it is moving away from does not exceed 110 ft² (10.2 m²) per sprinkler where all of the following conditions are met:

- The average actual floor area protected by the sprinklers on the moved branch line and the sprinklers on the adjacent branch lines does not exceed 100 ft² (9.3 m²) per sprinkler.
- The distance between sprinklers doesn't exceed 12 ft (3.7 m).
- It is NOT permitted to move a branch line where there are moved sprinklers on a branch line that exceed the maximum sprinkler spacing.

Minimum Distance Between Sprinklers: 8 ft (2.4 m) on center.

Minimum Distance from Walls: At least 4" (102 mm) from walls.

Maximum Distance from Walls: No more than one-half the allowable distance permitted between sprinklers, as indicated in Table 2.

Deflector Position:

- Under unobstructed construction, the deflector must be located between 6" (152 mm) and 12" (305 mm) below the ceiling.
- Under obstructed noncombustible construction, the deflector must be located in accordance with one of the following:
 1. With the deflector between 6" (152 mm) and 12" (305 mm) below the ceiling.
 2. With the deflector of sprinklers under concrete tee construction with stems spaced less than 7-1/2 ft (2.3 m) but more than 3 ft (0.9 m) on centers, regardless of the depth of the tee, located at or above a horizontal plane 1" (25.4 mm) below the bottom of the stems of the tees and shall comply with Table 10.

Obstructions at or Near the Ceiling: Sprinklers must be arranged to comply with Table 10 and Figure 3 on page 114r for obstructions at or near the ceiling, such as beams, ducts, lights, and top chords of trusses and bar joists. This requirement doesn't apply where sprinklers are spaced on opposite sides of obstructions less than 24" (610 mm) wide, provided the distance from the centerline on the obstructions to the sprinklers doesn't exceed one half the allowable distance between sprinklers.

Isolated Obstructions Below the Elevation of Sprinklers: Sprinklers must be arranged with respect to isolated obstructions in accordance with one of the following:

1. Sprinklers must be installed below isolated noncontinuous obstructions that restrict only one sprinkler and are located below the elevation of sprinklers such as light fixtures and unit heaters.
2. Additional sprinklers are not required where the obstruction is 2 ft (0.6 m) or less in width and the sprinkler is located horizontally 4" (102 mm) or more from the nearest edge of the obstruction.
3. Additional sprinklers are not required where sprinklers are positioned with respect to the bottom of obstructions in accordance with Table 10 and Figure 3 on page 114r.
4. Additional sprinklers are not required where the obstruction is 4" (102 mm) or less in width and in compliance with Figure 4, which illustrates sprinklers shall be positioned such that they are located at least a distance three times greater than the maximum dimension of the obstruction from the sprinkler, but never closer than 4" (102 mm) horizontally.

Continuous Obstructions Below the Sprinklers: Sprinklers must be arranged with respect to obstructions in accordance with one of the following:

1. Sprinklers must be installed below continuous obstructions, or they must be arranged to comply with Table 10 and Figure 3 on page 114r for horizontal obstructions entirely below the elevation of sprinklers that restrict sprinkler discharge pattern for two or more adjacent sprinklers, such as ducts, lights, pipes, and conveyors.
2. Additional sprinklers shall not be required where the obstruction is 4" (102 mm) or less in width and installed in accordance with Figure 4.
3. Additional sprinklers are not required where the obstruction is 1 ft (0.3 m) or less in width and located at least 1 ft (0.3 m) horizontally from the sprinkler.
4. Additional sprinklers are not required where the obstruction is 2 ft (0.6 m) or less in width and located a minimum of 2 ft (0.6 m) horizontally from the sprinkler.
5. Ceiling sprinklers are not required to comply with Table 10 where a row of sprinklers is installed under the obstruction.

Bottom Chords of Bar Joists or Open Trusses: Sprinklers shall be positioned a minimum of 4" (102 mm) horizontally from the nearest edge to any bottom chord of a bar joist or open truss.

Open Gratings: Sprinklers installed under open gratings must be of the intermediate level/rack storage type or otherwise shielded from the discharge of overhead sprinklers.

Overhead Doors: Quick response spray sprinklers are permitted to be utilized under overhead doors.



TECHNICAL DATA

STANDARD RESPONSE PENDENT SPRINKLER VK592 (K19.6) (CONTROL MODE SPECIFIC APPLICATION)

The Viking Corporation, 210 N Industrial Park Drive, Hastings MI 49058
Telephone: 269-945-9501 Technical Services: 877-384-5464 Fax: 269-818-1680 Email: techsvcs@vikingcorp.com

TABLE 2: UL-PROTECTION AREAS AND MAXIMUM SPACING OF VK592 SPRINKLERS

Construction Type	Ceiling/Roof Heights up to 40 ft (12.2 m)			
	Protection Area		Spacing	
Noncombustible unobstructed	100 ft ²	(9.3 m ²)	12 ft	(3.7 m)
Noncombustible obstructed	100 ft ²	(9.3 m ²)	12 ft	(3.7 m)
Combustible unobstructed	100 ft ²	(9.3 m ²)	12 ft	(3.7 m)
Combustible obstructed	N/A	N/A	N/A	N/A
Rack storage applications	100 ft ²	(9.3 m ²)	12 ft	(3.7 m)

TABLE 3: UL DESIGN CRITERIA - PALLETIZED AND SOLID-PILED STORAGE OF CLASS I-IV COMMODITIES USING CONTROL MODE SPECIFIC APPLICATION PENDENT SPRINKLER VK592

Configuration	Commodity Class	Maximum Storage Height		Maximum Ceiling/Roof Height		Number of Design Sprinklers	Minimum Operating Pressure	
		ft	(m)	ft	(m)		PSI	(bar)
Palletized and Solid Piled	Classes I-IV	25 ft	(7.6 m)	30 ft	(9.1 m)	15	16 PSI	(1.1 bar)
		30 ft	(9.1 m)	35 ft	(10.5 m)	15	25 PSI	(1.7 bar)
		35 ft	(10.5 m)	40 ft	(12.2 m)	15	30 PSI	(2.1 bar)

NOTE: Hose stream allowance shall be in accordance with NFPA 13 for Control Mode Specific Application Sprinklers.

TABLE 4: UL DESIGN CRITERIA - PALLETIZED AND SOLID-PILED STORAGE OF PLASTIC AND RUBBER COMMODITIES USING CONTROL MODE SPECIFIC APPLICATION PENDENT SPRINKLER VK592

Configuration	Commodity Class	Maximum Storage Height		Maximum Ceiling/Roof Height		Number of Design Sprinklers	Minimum Operating Pressure	
		ft	(m)	ft	(m)		PSI	(bar)
Palletized and Solid Piled Storage (no open-top containers or solid shelves)	Cartoned Unexpanded Plastics	20 ft	(6.1 m)	25 ft	(7.6 m)	15	16 PSI	(1.1 bar)
		20 ft	(6.1 m)	30 ft	(9.1 m)	15	16 PSI	(1.1 bar)
		20 ft	(6.1 m)	35 ft	(10.5 m)	15	25 PSI	(1.7 bar)
		20 ft	(6.1 m)	40 ft	(12.2 m)	15	30 PSI	(2.1 bar)
		25 ft	(7.6 m)	30 ft	(9.1 m)	15	16 PSI	(1.1 bar)
		25 ft	(7.6 m)	35 ft	(10.5 m)	15	25 PSI	(1.7 bar)
		25 ft	(7.6 m)	40 ft	(12.2 m)	15	30 PSI	(2.1 bar)
		30 ft	(9.1 m)	35 ft	(10.5 m)	15	25 PSI	(1.7 bar)
		30 ft	(9.1 m)	40 ft	(12.2 m)	15	30 PSI	(2.1 bar)
		35 ft	(10.5 m)	40 ft	(12.2 m)	15	30 PSI	(2.1 bar)

NOTE: Hose stream allowance shall be in accordance with NFPA 13 for Control Mode Specific Application Sprinklers.

TABLE 5: UL DESIGN CRITERIA - SINGLE-, DOUBLE-, AND MULTIPLE-ROW RACK STORAGE (WITHOUT SOLID SHELVES) OF CLASS I-IV COMMODITIES STORED UP TO AND INCLUDING 25 ft (7.6 m) HIGH USING CONTROL MODE SPECIFIC APPLICATION PENDENT SPRINKLER VK592

Configuration	Commodity Class	Maximum Storage Height		Maximum Ceiling/Roof Height		Number of Design Sprinklers	Minimum Operating Pressure	
		ft	(m)	ft	(m)		PSI	(bar)
Single-Row, Double-Row, and Multiple-Row Rack (no open-top containers)	Classes I-IV Encapsulated or Unencapsulated	20 ft	(6.1 m)	25 ft	(7.6 m)	15	16 PSI	(1.1 bar)
		20 ft	(6.1 m)	30 ft	(9.1 m)	15	16 PSI	(1.1 bar)
		20 ft	(6.1 m)	35 ft	(10.5 m)	15	25 PSI	(1.7 bar)
		20 ft	(6.1 m)	40 ft	(12.2 m)	15	30 PSI	(2.1 bar)
		25 ft	(7.6 m)	30 ft	(9.1 m)	15	16 PSI	(1.1 bar)
		25 ft	(7.6 m)	35 ft	(10.5 m)	15	25 PSI	(1.7 bar)
		25 ft	(7.6 m)	40 ft	(12.2 m)	15	30 PSI	(2.1 bar)

NOTE: Hose stream allowance shall be in accordance with NFPA 13 for Control Mode Specific Application Sprinklers.



TECHNICAL DATA

STANDARD RESPONSE PENDENT SPRINKLER VK592 (K19.6) (CONTROL MODE SPECIFIC APPLICATION)

The Viking Corporation, 210 N Industrial Park Drive, Hastings MI 49058
Telephone: 269-945-9501 Technical Services: 877-384-5464 Fax: 269-818-1680 Email: techsvcs@vikingcorp.com

TABLE 6: UL DESIGN CRITERIA - SINGLE-, DOUBLE-, AND MULTIPLE-ROW RACK STORAGE (WITHOUT SOLID SHELVES) OF CLASS I-IV COMMODITIES STORED OVER 25 ft (7.6 m) HIGH USING CONTROL MODE SPECIFIC APPLICATION PENDENT SPRINKLER VK592

Configuration	Commodity Class	Maximum Storage Height		Maximum Ceiling/ Roof Height		Number of Design Sprinklers	Minimum Operating Pressure	
		ft	(m)	ft	(m)		PSI	(bar)
Single-Row, Double-Row, and Multiple-Row Rack (no open-top containers)	Classes I-IV Encapsulated or Unencapsulated	30 ft	(9.1 m)	35 ft	(10.5 m)	15	25 PSI	(1.7 bar)
		30 ft	(9.1 m)	40 ft	(12.2 m)	15	30 PSI	(2.1 bar)
		35 ft	(10.5 m)	40 ft	(12.2 m)	15	30 PSI	(2.1 bar)

NOTE: Hose stream allowance shall be in accordance with NFPA 13 for Control Mode Specific Application Sprinklers.

TABLE 7: UL DESIGN CRITERIA - SINGLE-, DOUBLE-, AND MULTIPLE-ROW RACK STORAGE (WITHOUT SOLID SHELVES) OF PLASTIC COMMODITIES STORED UP TO AND INCLUDING 25 ft (7.6 m) HIGH USING CONTROL MODE SPECIFIC APPLICATION PENDENT SPRINKLER VK592

Configuration	Commodity Class	Maximum Storage Height		Maximum Ceiling/ Roof Height		Number of Design Sprinklers	Minimum Operating Pressure	
		ft	(m)	ft	(m)		PSI	(bar)
Single-Row, Double-Row, and Multiple-Row Rack (no open-top containers)	Cartoned Unexpanded Plastics	20 ft	(6.1 m)	25 ft	(7.6 m)	15	16 PSI	(1.1 bar)
		20 ft	(6.1 m)	30 ft	(9.1 m)	15	16 PSI	(1.1 bar)
		20 ft	(6.1 m)	35 ft	(10.5 m)	15	25 PSI	(1.7 bar)
		20 ft	(6.1 m)	40 ft	(12.2 m)	15	30 PSI	(2.1 bar)
		25 ft	(7.6 m)	30 ft	(9.1 m)	15	16 PSI	(1.1 bar)
		25 ft	(7.6 m)	35 ft	(10.5 m)	15	25 PSI	(1.7 bar)
		25 ft	(7.6 m)	40 ft	(12.2 m)	15	30 PSI	(2.1 bar)

NOTE: Hose stream allowance shall be in accordance with NFPA 13 for Control Mode Specific Application Sprinklers.

TABLE 8: UL DESIGN CRITERIA - SINGLE-, DOUBLE-, AND MULTIPLE-ROW RACK STORAGE (WITHOUT SOLID SHELVES) OF PLASTIC COMMODITIES STORED OVER 25 ft (7.6 m) HIGH USING CONTROL MODE SPECIFIC APPLICATION PENDENT SPRINKLER VK592

Configuration	Commodity Class	Maximum Storage Height		Maximum Ceiling/ Roof Height		Number of Design Sprinklers	Minimum Operating Pressure	
		ft	(m)	ft	(m)		PSI	(bar)
Single-Row, Double-Row, and Multiple-Row Rack (no open-top containers)	Cartoned Unexpanded Plastics	30 ft	(9.1 m)	35 ft	(10.5 m)	15	25 PSI	(1.7 bar)
		30 ft	(9.1 m)	40 ft	(12.2 m)	15	30 PSI	(2.1 bar)
		35 ft	(10.5 m)	40 ft	(12.2 m)	15	30 PSI	(2.1 bar)

NOTE: Hose stream allowance shall be in accordance with NFPA 13 for Control Mode Specific Application Sprinklers.

TABLE 9: UL DESIGN CRITERIA - ON FLOOR STORAGE OF IDLE WOOD PALLETS STORED UP TO AND INCLUDING 20 ft (7.6 m) HIGH USING CONTROL MODE SPECIFIC APPLICATION PENDENT SPRINKLER VK592

Configuration	Commodity Class	Maximum Storage Height		Maximum Ceiling/ Roof Height		Number of Design Sprinklers	Minimum Operating Pressure	
		ft	(m)	ft	(m)		PSI	(bar)
On Floor	Idle Wood Pallets	20 ft	(6.1 m)	25 ft	(7.6 m)	15	16 PSI	(1.1 bar)
		20 ft	(6.1 m)	30 ft	(9.1 m)	15	16 PSI	(1.1 bar)
		20 ft	(6.1 m)	35 ft	(10.5 m)	15	25 PSI	(1.7 bar)
		20 ft	(6.1 m)	40 ft	(12.2 m)	15	30 PSI	(2.1 bar)

NOTE: Hose stream allowance shall be in accordance with NFPA 13 for Control Mode Specific Application Sprinklers.



TECHNICAL DATA

**STANDARD RESPONSE
PENDENT SPRINKLER
VK592 (K19.6)**
(CONTROL MODE SPECIFIC APPLICATION)

The Viking Corporation, 210 N Industrial Park Drive, Hastings MI 49058
 Telephone: 269-945-9501 Technical Services: 877-384-5464 Fax: 269-818-1680 Email: techsvcs@vikingcorp.com

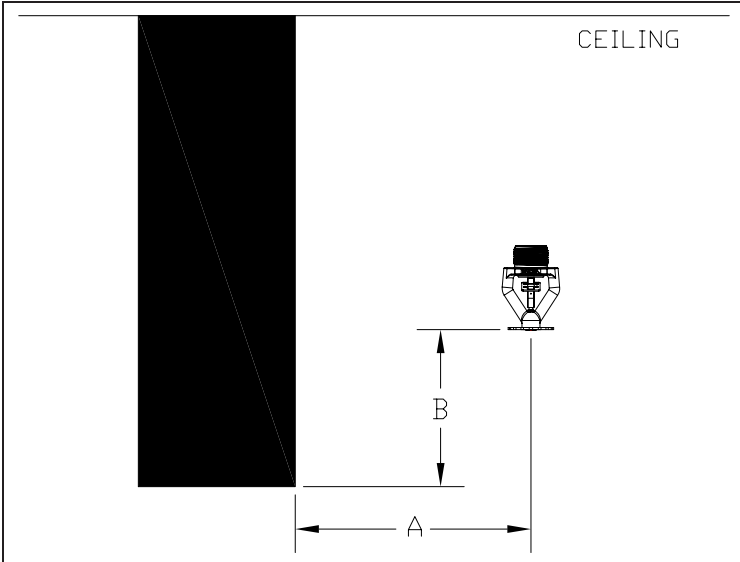
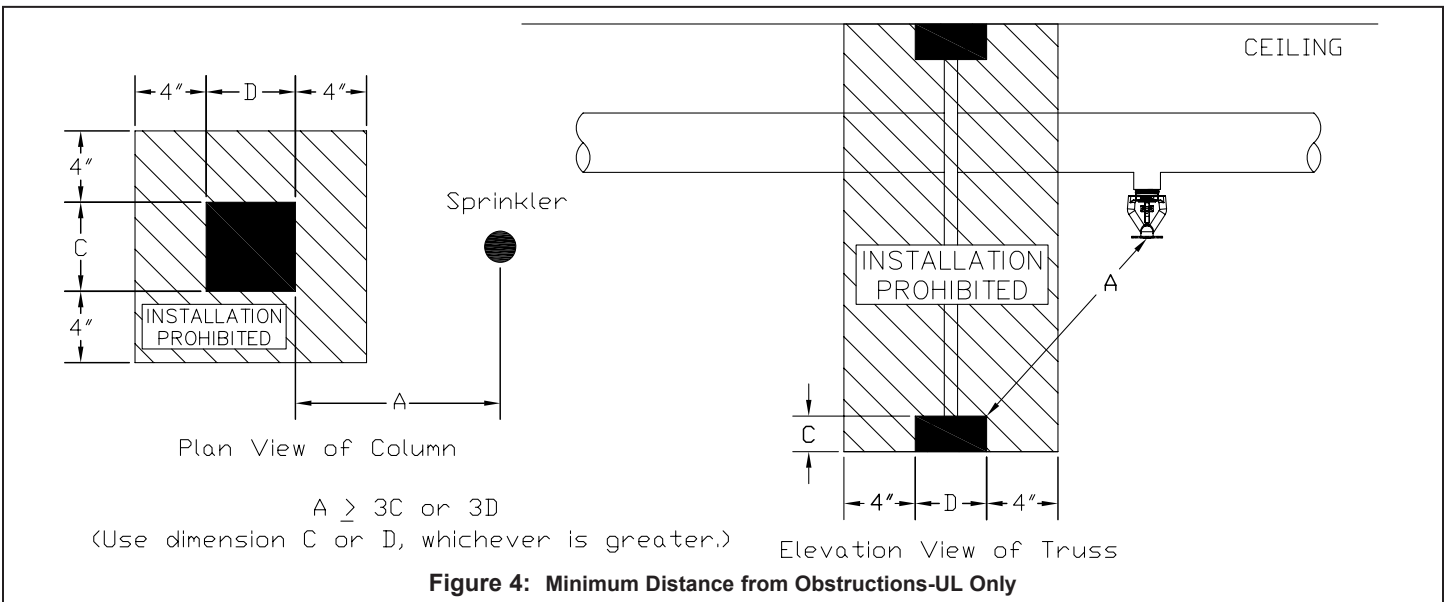



Figure 3:
Positioning of Sprinklers to Avoid Obstructions to Discharge

TABLE 10: POSITIONING SPRINKLER VK592 TO AVOID OBSTRUCTIONS TO DISCHARGE-UL ONLY

Distance from Sprinkler to Side of Obstruction (A)		Maximum Allowable Distance of Deflector Above Bottom of Obstruction (B)	
U.S.	metric	inches	mm
Less than 1 ft	Less than .3048 m	0	0
1 ft to less than 1 ft 6 in.	.3048 m to less than .46 m	1-1/2"	38.1 mm
1 ft 6 in. to less than 2 ft	.46 m to less than .61 m	3"	76.2 mm
2 ft to less than 2 ft 6 in.	.61 m to less than .76 m	5-1/2"	139.7 mm
2 ft 6 in. to less than 3 ft	.76 m to less than .91 m	8"	203.2 mm
3 ft to less than 3 ft 6 in.	.91 m to less than 1.07 m	10"	254 mm
3 ft 6 in. to less than 4 ft.	1.07 m to less than 1.22 m	12"	304.8 mm
4 ft to less than 4 ft 6 in.	1.22 m to less than 1.37 m	15"	381 mm
4 ft 6 in. to less than 5 ft	1.37 m to less than 1.52 m	18"	457.2 mm
5 ft to less than 5 ft 6 in.	1.52 m to less than 1.7 m	22"	558.8 mm
5 ft 6 in. to less than 6 ft	1.7 m to less than 1.83 m	26"	660.4 mm
6 ft	1.83 m	31"	787.4 mm



	TECHNICAL DATA	STANDARD RESPONSE PENDENT SPRINKLER VK592 (K19.6) (CONTROL MODE SPECIFIC APPLICATION)
---	-----------------------	--

The Viking Corporation, 210 N Industrial Park Drive, Hastings MI 49058
 Telephone: 269-945-9501 Technical Services: 877-384-5464 Fax: 269-818-1680 Email: techsvcs@vikingcorp.com

Approval Chart 2 (FM) Standard Response Pendent Sprinkler VK592 (K19.6) Maximum 175 PSI (12 Bar) WWP							<table border="1" style="width: 100%; border-collapse: collapse;"> <tr> <td style="font-size: small;">Temperature</td> <td style="text-align: right;">KEY</td> </tr> <tr> <td style="font-size: small;">Finish</td> <td></td> </tr> <tr> <td style="font-size: small;">A1X ← Escutcheon (if applicable)</td> <td></td> </tr> </table>	Temperature	KEY	Finish		A1X ← Escutcheon (if applicable)	
Temperature	KEY												
Finish													
A1X ← Escutcheon (if applicable)													
Base Part Number ¹	SIN	Thread Size	Nominal K-Factor		Overall Length		FM Approvals ^{3,4} (Refer also to Design Criteria below.)						
			U.S.	metric ²	Inches	mm							
14243A	VK592	1" NPT	19.6	282.6	3-3/16	81	A1						
15468A	VK592	25 mm BSP	19.6	282.6	3-3/16	81	A1						
Approved Temperature Ratings A - 160 °F (71 °C) and 205 °F (96 °C)						Approved Finish 1 - Brass							
Footnotes ¹ Base part number shown. For complete part number, refer to Viking's current price schedule. ² Metric K-factor measurement shown is when pressure is measured in Bar. When pressure is measured in kPa, divide the metric K-factor shown by 10.0. ³ This table shows the listings and approvals available at the time of printing. Other approvals may be in process. ⁴ FM Approved as a standard response pendent Non-Storage sprinkler and also FM Approved as a standard response pendent Storage sprinkler. Refer to Design Criteria below.													

DESIGN CRITERIA - FM (Also refer to Approval Chart 2 above.)
<p>FM Approval Requirements:</p> <ol style="list-style-type: none"> Sprinkler VK592 is FM Approved as a standard response pendent Storage sprinkler as indicated in the FM Approval Guide. <ul style="list-style-type: none"> For specific application and installation requirements, reference the latest applicable FM Loss Prevention Data Sheets (including Data Sheets 2-0 and 8-9). Sprinkler VK592 is also FM Approved as a standard response pendent Non-Storage sprinkler as indicated in the FM Approval Guide. <ul style="list-style-type: none"> For specific application and installation requirements, reference the latest applicable FM Loss Prevention Data Sheets (including Data Sheet 2-0). <p>FM Global Loss Prevention Data Sheets contain guidelines relating to, but not limited to: minimum water supply requirements, hydraulic design, ceiling slope and obstructions, minimum and maximum allowable spacing, and deflector distance below the ceiling.</p> <p>NOTE: The FM installation guidelines may differ from UL and/or NFPA criteria.</p> <p>IMPORTANT: Always refer to Bulletin Form No. F_091699 - Care and Handling of Sprinklers. Also refer to page SR1-3 for general care, installation, and maintenance information. Viking sprinklers are to be installed in accordance with the latest edition of Viking technical data, the appropriate standards of NFPA, FM Global, LPCB, APSAD, VdS or other similar organizations, and also with the provisions of governmental codes, ordinances, and standards, whenever applicable.</p>